



# Carrozze - Coaches



## 1015

Confezione di tre carrozze composta da: una carrozza pilota due piani di seconda classe e due carrozze due piani di seconda classe nella livrea d'origine con logo FS inclinato.

*Set composed by one 2nd class double deck pilot coach and two 2nd class double deck coaches in the original liveries.*

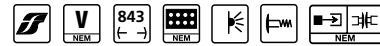

## 1010

Confezione di tre carrozze composta da: una carrozza pilota due piani di seconda classe e due carrozze due piani di seconda classe nella livrea d'origine con logo FS anni '70 "telesivore".

*Set composed by one 2nd class double deck pilot coach and two 2nd class double deck coaches in the original liveries with FS logo age '70.*

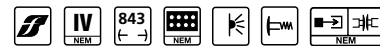

**NEW 2011**

## 3071

Carrozza pilota due piani di seconda classe nella livrea d'origine con logo FS inclinato, nuova numerazione.

*Pilot coach 2nd class double deck coach in the original livery, new service number.*

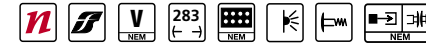

## 3072

Carrozza due piani di seconda classe nella livrea d'origine con logo FS inclinato, nuova numerazione.

*2nd class double deck coach in the original livery, new service number.*

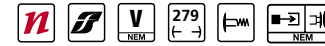

**NEW 2011**



**NEW 2011**

## 3066

Carrozza due piani di seconda classe nella livrea d'origine con logo FS anni '70, nuova numerazione.

*2nd class double deck coach in the original livery with FS logo age '70 and new service numbers.*

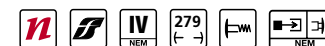



# TRANSILIEN

Nouveau moule en préparation.

La SNCF, le STIF et la région Ile de France décident de procéder à la modernisation profonde des VB2N. La livrée Transilien bleu marine et blanche comporte des berlingots de couleur rouge ou bleue au niveau des portes d'accès, ils sont de couleur orange pour signaler l'accès aux personnes à mobilité réduite et vertes au niveau de l'accès à l'espace vélo. Il n'y a plus de store ou de rideau, les vitres sont teintées et les voitures reçoivent la ventilation réfrigérée.

## 1035

- Confezione di 4 carrozze VB2N con carrozza pilota, una carrozza di 2a classe, una carrozza di 1a/2a classe e una carrozza d'estremità nei colori "Transilien" delle SNCF.
- Set of 4 coaches VB2N with driving coach, 2nd class coach, 1st/2nd class coach and one end of convoy coach at side of the locomotive in the "Transilien" of the SNCF.
- Coffret de 4 voitures SNCF VB2N rénovées, livrée Transilien, logo "carmillon" avec une voiture pilote, une voiture d'extrémité, une voiture 2ème classe et une voiture mixte 2ème classe/Vélos.

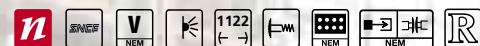

Nuovo stampo in preparazione.

La SNCF, lo STIF e la Regione Ile de France decisero di modernizzare completamente le VB2N. La Transilien blu marine e bianco ha attorno alle porte di accesso delle zone colorate in rosso o blu. Il colore arancione indica l'entrata per le persone a mobilità ridotta mentre il verde è per l'accesso rapido. Non ci sono più tende, i vetri sono tinti e in ogni vettura c'è l'aria condizionata.

## 3048

- Carrozza VB2N di seconda classe nella livrea "Transilien" delle SNCF.
- 2nd class coach VB2N in the "Transilien" livery of the SNCF.
- Voiture SNCF VB2N rénovée, 2ème classe livrée Transilien, logo carmillon.

## 3049

- Carrozza VB2N di seconda classe nella livrea "Transilien" delle SNCF, con nuova numerazione.
- 2nd class coach VB2N in the "Transilien" livery of the SNCF, with new service number.
- Voiture SNCF VB2N rénovée, 2ème classe livrée Transilien, logo carmillon, immatriculation différente.

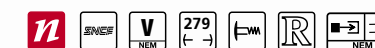

© Foto B. Bayle



# VOITURES V2N SNCF



**3074**

- Carrozza VB2N di seconda classe delle SNCF.
- 2nd class coach VB2N of the SNCF.
- Voiture SNCF VB2N, 2ème classe, logo encadré.

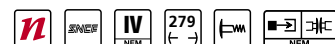

**NEW 2011**

**1072**

- Confezione di 4 carrozze VB2N con carrozza pilota, una carrozza di 2a classe, una carrozza di 1a/2a classe e una carrozza d'estremità nei colori d'origine grigio-arancio anni 1976 -1988 delle SNCF.
- Set of 4 coaches VB2N with driving coach, 2nd class coach, 1st/2nd class coach and one end of convoy coach at side of the locomotive in the age 1976 - 1988 original liveries gray-orange of the SNCF.
- Coffret de 4 voitures SNCF VB2N, livrée d'origine gris orange, Années 1976-1988, logo encadré, avec une voiture pilote, une voiture d'extrémité, une voiture 2ème classe et une voiture mixte 1ère / 2ème classe.

**NEW 2011**

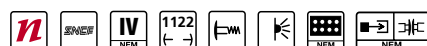

# ILE DE FRANCE

**1054**

- Confezione di 4 carrozze VB2N con carrozza pilota, una carrozza di 2a classe, una carrozza di 1a/2a classe e una carrozza d'estremità nei colori "Ile de France" blu-bianco-rosso SNCF.
- Set of 4 coaches VB2N with driving coach, 2nd class coach, 1st/2nd class coach and one end of convoy coach at side of the locomotive in the "Ile de France" liveries blue-white-red of the SNCF.
- Coffret de 4 voitures SNCF VB2N, livrée bleu-blanc-rouge "Ile de France", logo "casquette" avec une voiture pilote, une voiture d'extrémité, une voiture 2ème classe et une voiture mixte 1ère / 2ème classe.



**3053**

- Carrozza VB2N di prima/seconda classe delle SNCF.
- 1st/2nd class coach VB2N of the SNCF.
- Voiture SNCF VB2N de 1ère/2ème classe, logo "nouille".

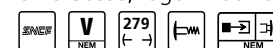

**3044**

- Carrozza VB2N di seconda classe delle SNCF.
- 2nd class coach VB2N of the SNCF.
- Voiture SNCF VB2N de 2ème classe, logo "nouille".



**1033**

- Confezione di 4 carrozze VB2N con carrozza pilota, una carrozza di 2a classe, una carrozza di 1a/2a classe e una carrozza d'estremità nei colori d'origine grigio-arancio anni 1988 - 1995 delle SNCF, nuova numerazione.
- Set of 4 coaches VB2N with driving coach, 2nd class coach, 1st/2nd class coach and one end of convoy coach at side of the locomotive in the age 1988 - 1995 original liveries gray-orange of the SNCF, with new service numbers.
- Coffret de 4 voitures SNCF VB2N, livrée d'origine gris orange, Années 1988-1995, logo "nouille" avec une voiture pilote, une voiture d'extrémité, une voiture 2ème classe et une voiture mixte 1ère / 2ème classe, nouvelle immatriculation.



**3054**

- Carrozza VB2N di seconda classe delle SNCF.
- 2nd class coach VB2N of the SNCF.
- Voiture SNCF VB2N, "Ile de France", 2ème classe.

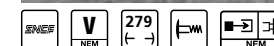

**3056**

- Carrozza VB2N di 1a/2a classe delle SNCF nuova numerazione.
- 1st/2nd class coach VB2N of the SNCF with new service number.
- Voiture SNCF VB2N, "Ile de France", 1ère / 2ème classe, avec nouvelle immatriculation.





# REGION CENTRE



## 1062

- Confezione di 4 carrozze VO2N con carrozza pilota, una carrozza di 2a classe, una carrozza di 1a classe e una carrozza d'estremità nella nuova livrea TER grigio-bianco-blu della regione "CENTRE", con logo "carmillon", delle SNCF.

- Set of 4 coaches VB2N with driving coach, 2nd class coach, 1st class coach and one end of convoy coach at side of the locomotive in the TER liveries gray-white-blue of the "CENTRE" region, with "carmillon" logo, of the SNCF.

- Coffret de 4 voitures SNCF VO2N, livrée TER Centre, logo "carmillon", avec une voiture pilote, une voiture 2ème classe et une voiture 1ère classe.

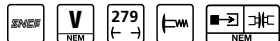
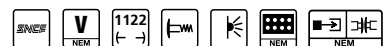

## 3062

- Carrozza VO2N di 2a classe con logo "carmillon" delle SNCF.  
- 2nd class coach VO2N with "carmillon" logo, of the SNCF.  
- Voiture SNCF VO2N, 2ème classe, logo "carmillon".



# NORD PAS DE CALAIS



## 1034

- Confezione di 4 carrozze VR2N con carrozza pilota, una carrozza di 2a classe, una carrozza di 1a/2a classe e una carrozza d'estremità nei colori "Nord Pas de Calais" blu-bianco-giallo SNCF.

- Set of 4 coaches VR2N with driving coach, 2nd class coach, 1st/2nd class coach and one end of convoy coach at side of the locomotive in the "Nord Pas de Calais" liveries blue-white-yellow of the SNCF.

- Coffret de 4 voitures SNCF VR2N, livrée TER Nord-Pas de Calais, logo "casquette" avec une voiture pilote, une voiture d'extrémité, une voiture 2ème classe et une voiture mixte 1ère / 2ème classe.

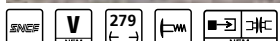

## 3046

- Carrozza VR2N di seconda classe delle SNCF.  
- 2nd class coach VR2N of the SNCF.  
- Voiture SNCF VR2N, 2ème classe, logo casquette.



# TER PICARDIE



## 1018

- Confezione di 4 carrozze VO2N con carrozza pilota, una carrozza di 2a classe, una carrozza di 1a classe e una carrozza d'estremità nella nuova livrea TER Picardie grigio-bianco-blu, con logo "carmillon", delle SNCF.

- Set of 4 coaches VB2N with driving coach, 2nd class coach, 1st class coach and one end of convoy coach at side of the locomotive in the TER Picardie liveries gray-white-blue, with "carmillon" logo, of the SNCF.

- Coffret de 4 voitures SNCF VO2N, livrée TER Picardie, logo "carmillon", avec une voiture pilote, une voiture d'extrémité, une voiture 2ème classe et une voiture 1ère classe.

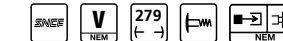

## 3033

- Carrozza VO2N di 2a classe nella livrea TER Picardie, con logo "carmillon" delle SNCF.  
- 2nd class coach VO2N in the TER Picardie livery, with "carmillon" logo, of the SNCF.  
- Voiture SNCF VO2N, 2ème classe livrée TER Picardie, logo "carmillon".



# REGION CENTRE



## 1008

- Confezione di 4 carrozze VO2N con carrozza pilota, una carrozza di 2a classe, una carrozza di 1a classe e una carrozza d'estremità nella nuova livrea TER grigio-bianco-blu della regione "CENTRE" delle SNCF.

- Set of 4 coaches VB2N with driving coach, 2nd class coach, 1st class coach and one end of convoy coach at side of the locomotive in the TER liveries gray-white-blue of the "CENTRE" region of the SNCF.

- Coffret de 4 voitures SNCF VO2N, livrée TER Centre, logo "casquette", avec une voiture pilote, une voiture d'extrémité, une voiture 2ème classe et une voiture 1ère classe.

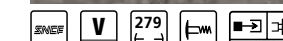

## 3006

- Carrozza VO2N di 2a classe delle SNCF.  
- 2nd class coach VO2N of the SNCF.  
- Voiture SNCF VO2N, 2ème classe livrée TER Centre, logo "casquette"





# Carri merci - Freight wagons

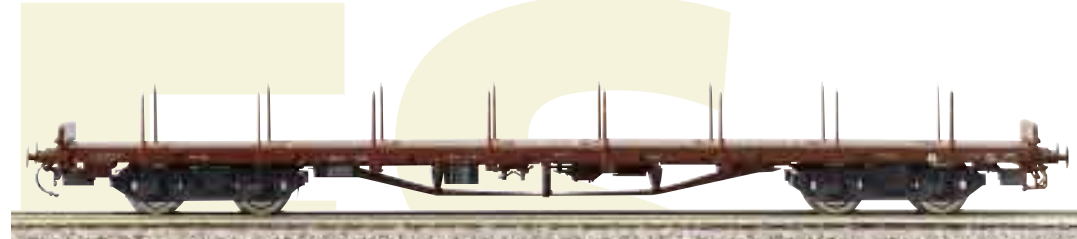

**3300**  
Carro pianale tipo Rs delle FS.  
*Rs flat car of the FS.*

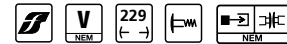

# FS

**3307**  
Set di due carri pianale tipo Rs delle FS.  
*Set of two Rs flat cars of the FS.*

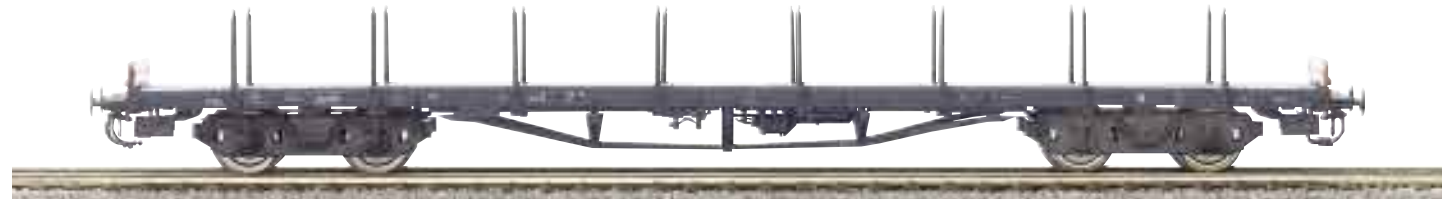
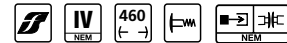

**3301**  
Carro pianale tipo Rs 680 delle DB, IV epoca.  
*Rs 680 flat car of the DB, epoch IV.*

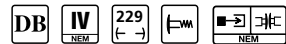

**3310**  
Set di due carri pianale SSImas 53 delle DB, epoca IIIb.  
*Set of two SSImas 53 flat cars of the DB, epoch IIIb.*

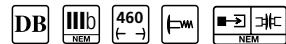

# Carri merci - Freight wagons

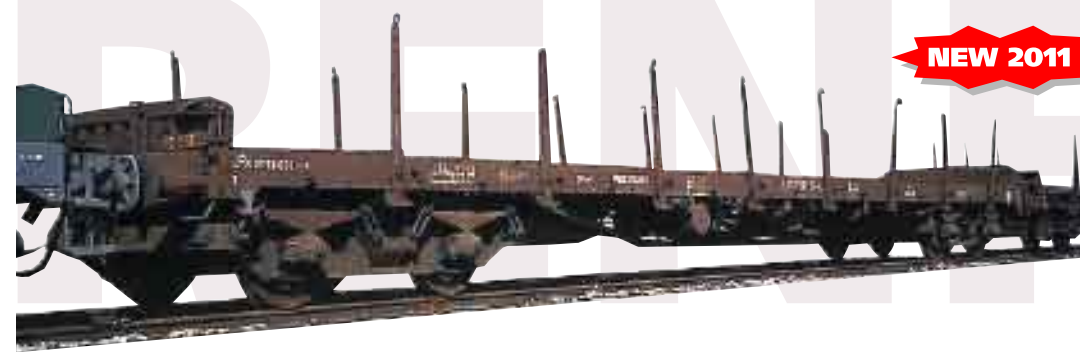

**NEW 2011**

**3304**  
Carro pianale tipo Rs delle RENFE.  
*Rs flat car of the RENFE.*

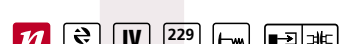

**3306**  
Carro pianale tipo Rs 802 delle SNCF.  
*Rs 802 flat car of the SNCF.*

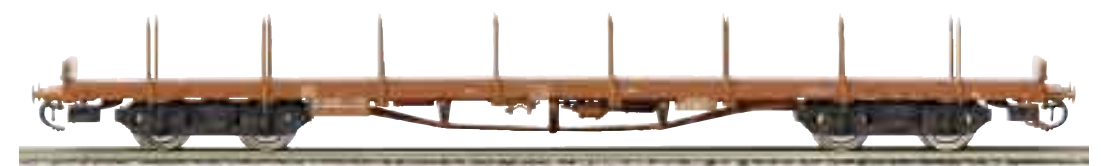
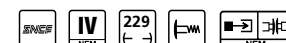

**3309**  
Set di due carri pianale tipo Rs 802 delle SNCF.  
*Set of two Rs 802 flat cars of the SNCF.*



# DB



# Carri merci - Freight wagons

# Carri merci - Freight wagons



**3303**  
Carro pianale tipo Rs 344 delle NS, nuova numerazione.  
*Rs 344 flat car of the NS, new service numbers.*

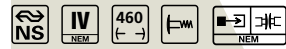

**3311**  
Set di due carri pianale tipo Rs 344 delle NS.  
*Set of two Rs 344 flat cars of the NS.*

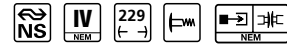

**3305**  
Carro pianale tipo Rs delle CFL.  
*Rs flat car of the CFL.*

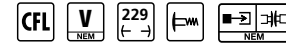

**3312**  
Set di due carri pianale tipo Rs delle CFL.  
*Set of two Rs flat cars of the CFL.*

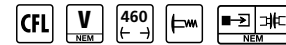

**3302**  
Carro pianale tipo Rs delle SNCB.  
*Rs flat car of the SNCB.*

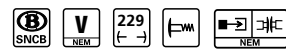

**3308**  
Set di due carri pianale tipo Rs delle SNCB.  
*Set of two Rs flat cars of the SNCB.*

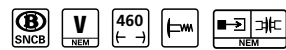



# Pantografi - Pantographs



**6042**  
Confezione 2 pantografi FS 42.  
Box of 2 FS 42 pantographs.



**6052**  
Confezione 2 pantografi FS 52.  
Box of 2 FS 52 pantographs.



**6043**  
Confezione 2 pantografi FS 42 LR unificato.  
Box of 2 FS 42 LR pantographs.



**6053**  
Confezione 2 pantografi FS 52/90 con strisciante piano.  
Box of 2 FS 52/90 pantographs.



**6050**  
Confezione 2 pantografi tipo AM Faiveley con strisciante SNCB.  
Box of 2 pantographs w/AM Faiveley shoes SNCB.



**6051**  
Confezione 2 pantografi tipo AM Faiveley con strisciante DB.  
Box of 2 pantographs w/AM Faiveley shoes DB.



**6055**  
Confezione 2 pantografi tipo AM Faiveley con strisciante SNCF.  
Box of 2 pantographs w/AM Faiveley shoes SNCF.



**6056**  
Confezione 2 pantografi tipo AM Faiveley con strisciante SBB.  
Box of 2 pantographs w/AM Faiveley shoes SBB.



**6072**  
Confezione 2 pantografi tipo AM 11 delle SNCF.  
Box of 2 pantographs AM 11 shoes SNCF.



**6073**  
Confezione 2 pantografi tipo AM Faiveley con strisciante FS.  
Box of 2 pantographs w/AM Faiveley shoes FS.

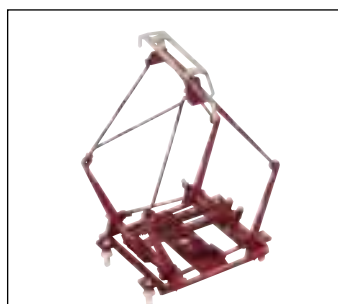

**6074**  
Confezione 2 pantografi FS 52/92 con strisciante piano.  
Box of 2 FS 52/92 pantographs.

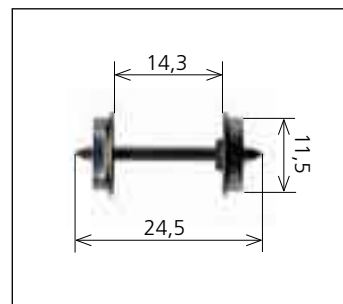

**6047**  
Confezione 4 assali Ø 11,5 mm.  
Box of 4 axles Ø 11,5 mm.

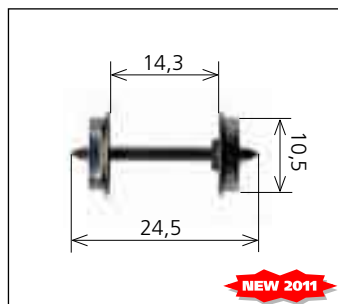

**6048**  
Confezione 4 assali Ø 10,5 mm.  
Box of 4 axles Ø 10,5 mm.

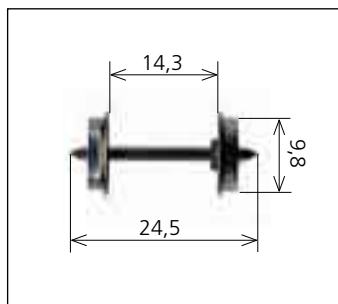

**6049**  
Confezione 4 assali Ø 9,8 mm.  
Box of 4 axles Ø 9,8 mm.

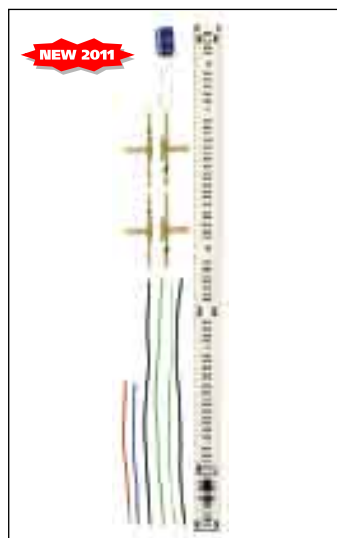

**6075**  
Confezione contenente kit di illuminazione per la carrozza MDVE delle FS.  
Lighting kit for MDVE passenger coach of the FS.

**6076**  
Confezione contenente kit di illuminazione per le carrozze pilota MDVC delle FS.  
Lighting kit for MDVC driving coach of the FS.

# Binari - Tracks



**4051**  
Binario flessibile set 24 pezzi L. 900 mm  
Flexible track - Length 900 mm. Box of 24 pieces

**4050**  
Binario flessibile set 100 pezzi L. 900 mm  
Flexible track - Length 900 mm. Box of 100 pieces



**4101**  
Confezione 100 giunti metallici.  
Metal fishplates. Box of 100 pcs.

# Peco - Uhlenbrock Elektronik

Distributore per l'Italia.  
Distributors for Italy.







ViTrains srl - Via A. Volta, 15  
36030 Costabissara - VI - Italy  
e-mail: info@vittrains.it  
web address: www.vittrains.it

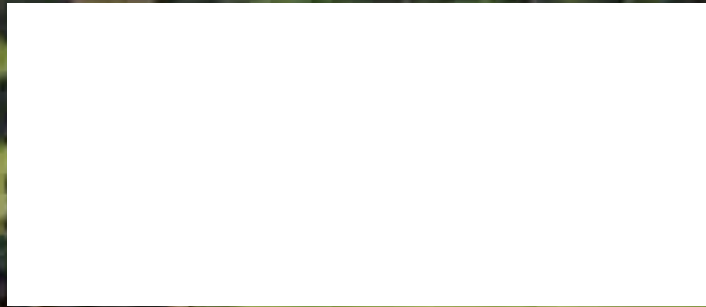

Export sales office:  
A.W.E.C.O. srl - All World Export Company - Via C. Scarpa, 140  
36100 Vicenza - Italy - web address: www.aweco.net  
e-mail: info@aweco.net



**2011**  
**H0 1:87**  
**Made in Italy**



© Plastico Fermodellisti Alto Vicentino - Schio