

Série 16 SNCB

2169

Locomotiva elettrica Tipo 1603 con 4 pantografi SNCB.
Electric Locomotive Class 1603 with 4 pantographs SNCB.

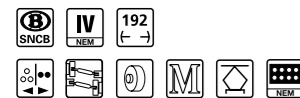

2369

Come articolo 2169 con digitale 3AC.
Like code 2169 with digital 3AC.



2166

Locomotiva elettrica Tipo 1606 SNCB livrea attuale blu con banda fascia gialla sul frontale con logo "Magellano".

Electric Locomotive Class 1606 SNCB in its current livery blue with a front yellow stripe with "Magellano" logo.



2170

Locomotiva elettrica Tipo 1602 SNCB.

Electric Locomotive Class 1602 SNCB.



2163

Locomotiva elettrica Tipo 1602 SNCB.

Electric Locomotive Class 1602 SNCB.



2363

Come articolo 2163 con digitale 3AC.
Like code 2163 with digital 3AC.



Série 16 SNCB

2168

Locomotiva elettrica tipo 1608 SNCB livrea dorata con banda gialla sul frontale.

Electric Locomotive Class 1608 SNCB in golden livery with a front yellow stripe.



2167

Locomotiva elettrica Tipo 1607 nella livrea d'origine SNCB.

Electric Locomotive Class 1607 in the original livery SNCB.



2367

Come articolo 2167 con digitale 3AC.

Like code 2167 with digital 3AC.



2362

Locomotiva elettrica tipo 1602 SNCB, con 4 pantografi "Svizzera" per treno Freccia del Sole, con digitale 3AC.

Electric Locomotive Class 1602 SNCB in the original livery w/4 pantographs Swiss "Freccia del Sole", with digital 3AC.



2171

Locomotiva elettrica Tipo 1601 SNCB.

Electric Locomotive Class 1601 SNCB.



2160

Locomotiva elettrica tipo 160.024 SNCB livrea d'origine.

Electric Locomotive Class 160.024 in the original livery SNCB.

2360

Come articolo 2160 con digitale 3AC.

Like code 2160 with digital 3AC.

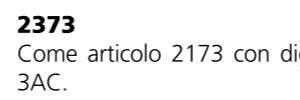

2173

Locomotiva elettrica tipo 160.022 SNCB livrea d'origine

Electric Locomotive Class 160.022 in the original livery SNCB.

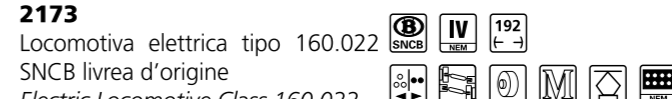

MDVC

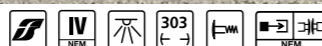
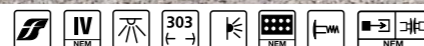

NEW

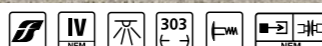
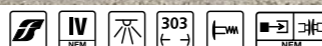

NEW



3080
Carrozza semipilota TD di 2 classe MDVC nella livrea d'origine con logo FS inclinato. Con illuminazione interna. *TD semi-driving 2nd class coach MDVC in the original livery with inclined logo FS. Interiors with lighting.*

3064
Carrozza di seconda classe nella livrea d'origine con logo FS anni '70 "tevisiore" e numeri di classe metallizzati. Con illuminazione interna. *2nd class coach in the original livery with FS logo age '70 and 2nd number in metal. Interiors with lighting.*

3093
Carrozza di seconda classe nella livrea d'origine con logo FS anni '70 "tevisiore" con diversa numerazione. Con illuminazione interna. *2nd class coach in the original livery with FS logo age '70 with different service number. Interiors with lighting.*

3065
Carrozza di seconda classe nella livrea d'origine con logo FS inclinato. Con illuminazione interna. *2nd class coach in the original livery with inclined logo FS. Interiors with lighting.*

3058
Carrozza di 1a/2a classe MDVC nella livrea d'origine con logo FS inclinato. Con illuminazione interna. *1st/2nd class coach MDVC in the original livery with inclined logo FS. Interiors with lighting.*

3094
Carrozza di 1a/2a classe MDVC nella livrea d'origine con logo FS inclinato. Con illuminazione interna. *1st/2nd class coach MDVC in the original livery with inclined logo FS. Interiors with lighting.*

Illuminazione interna a luce costante

MDVC



3079
Carrozza semipilota TE di 2a classe MDVC con nuovo logo Trenitalia "Gruppo Ferrovie dello Stato". Con illuminazione interna. *TE Semi-driving 2nd class coach MDVC of the FS Trenitalia livery. Interiors with lighting.*

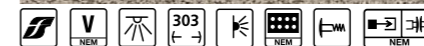

3077
Carrozza di 2a classe MDVC con nuovo logo Trenitalia "Gruppo Ferrovie dello Stato". Con illuminazione interna. *2nd class coach MDVC of the FS Trenitalia livery. Interiors with lighting.*

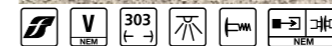

3078
Carrozza di 1a classe MDVC con nuovo logo Trenitalia "Gruppo Ferrovie dello Stato". Con illuminazione interna. *1st class coach MDVC of the FS Trenitalia livery. Interiors with lighting.*

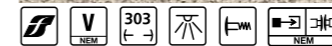

3057
Carrozza di 1a/2a classe MDVC con nuovo logo Trenitalia "Gruppo Ferrovie dello Stato". Con illuminazione interna. *1st/2nd class coach MDVC of the FS Trenitalia livery. Interiors with lighting.*

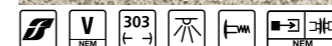

1064
Set composto da 3 carrozze MDVC: una carrozza semipilota TE nella livrea grigia/rosso fuoco e due carrozze di seconda classe nella livrea d'origine con logo FS inclinato. Con illuminazione interna. *Set of 3 cars MDVC: 1 TE semi-driving 2nd class car in red/grey livery + 2 passenger cars 2nd class in the original livery with inclined FS logo. Interiors with lighting.*



W/STEADY LIGHTING



3047
Carrozza semipilota TD di 2 classe MDVC nella livrea d'origine delle FS.
TD Semi-driving 2nd class coach MDVC in the original livery.

3047L
Come art. 3047 con illuminazione interna.
Like code 3047 with interiors lighting.



3092
Carrozza di 1a classe MDVE nella livrea d'origine delle FS.
1st class coach MDVE in the original livery.

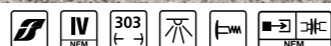

3083
Carrozza di 2a classe MDVE nella livrea d'origine delle FS.
Con illuminazione interna.
2nd class coach MDVE in the original livery. Interiors with lighting.

3084
Come art. 3083 ma con diversa numerazione.
Like code 3083 with different service number.

1049
Set composto da 3 carrozze: una carrozza semipilota TE e due carrozze di seconda classe MDVE nella livrea d'origine delle FS.
Set of 3 cars: 1 TE semi-driving 2nd class car + 2 MDVE passenger cars 2nd class in the original livery.

1049L
Come art. 1049 con illuminazione interna.
Like code 1049 with interiors lighting.



illuminazione interna a luce costante



NEW

3095
Carrozza MDVE "CONFERENZE" delle FS.
"CONFERENZE" coach MDVE of the FS.

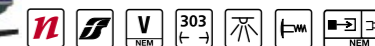

3085
Carrozza MDVE "Sleeperette" delle FS.
"Sleeperette" coach MDVE of the FS.

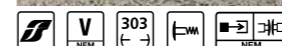

NEW

3096
Carrozza MDVE "RELAX" delle FS.
"RELAX" coach MDVE of the FS.

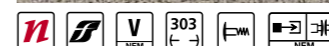

3081
Carrozza di 2a classe MDVE nella livrea XMPR delle FS Trenitalia.
Con illuminazione interna.
2nd class coach MDVE of the FS Trenitalia. Interiors with lighting.

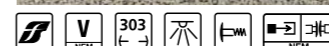

3082
Carrozza di 1a classe MDVE nella livrea XMPR delle FS Trenitalia.
Con illuminazione interna.
1st class coach MDVE of the FS Trenitalia. Interiors with lighting.

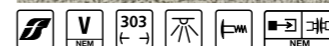

1080
Set composto da 3 carrozze: una carrozza semipilota TE - MDVC nella livrea XMPR delle FS Trenitalia e due carrozze di 2a classe MDVE nella livrea XMPR delle FS Trenitalia.
Con illuminazione interna.
Set of 3 cars: 1 TE semi-driving 2nd class car in the XMPR livery of the FS Trenitalia + 2 MDVE passenger cars 2nd class in the XMPR livery of the FS Trenitalia. Interiors with lighting.



W/STEADY LIGHTING

TRENORD

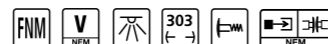

3086
Carrozza MDVC di 1/2a classe nella livrea "TRENORD".
1st/2nd class coach MDVC in the "TRENORD" livery.

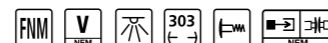

3087
Carrozza MDVC di 1a classe nella livrea "TRENORD".
1st class coach MDVC in the "TRENORD" livery.

TRENORD

3101
Carrozza due piani di seconda classe nella livrea "TRENORD".
2nd class double deck coach in the "TRENORD" livery.

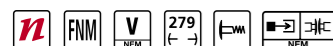

3102
Carrozza due piani di seconda classe nella livrea "TRENORD", diversa numerazione.
2nd class double deck coach in the "TRENORD" livery, different service number.

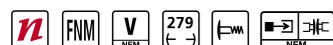

3103
Carrozza pilota due piani di seconda classe nella livrea "TRENORD".
Pilot coach 2nd class double deck coach in the "TRENORD" livery.



TRENORD

NEW

3105
Carrozza MDVC di 1a classe nella livrea "TRENORD".
1st class coach MDVC in the "TRENORD" livery.



NEW

3104
Carrozza MDVC di 2a classe nella livrea "TRENORD".
2nd class coach MDVC in the "TRENORD" livery.



TRENITALIA

NEW

3099
Carrozza pilota due piani di seconda classe con nuovo logo Trenitalia.
Pilot coach 2nd class double deck coach with new logo Trenitalia.



NEW

3097
Carrozza due piani di seconda classe con nuovo logo Trenitalia.
2nd class double deck coach with new logo Trenitalia.

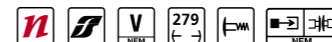

NEW

3098
Carrozza due piani di seconda classe con nuovo logo Trenitalia, diversa numerazione.
2nd class double deck coach with new logo Trenitalia, different service number.

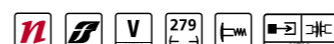

Carrozze - Coaches

3073

Carrozza pilota due piani di seconda classe delle FS Trenitalia.
Pilot coach 2nd class double deck coach of the FS Trenitalia.



3036

Carrozza due piani di 1/2 classe delle FS Trenitalia.
1st/2nd class double deck coach of the FS Trenitalia.

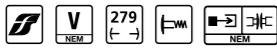

3071

Carrozza pilota due piani di seconda classe nella livrea d'origine con logo FS inclinato, diversa numerazione.
Pilot coach 2nd class double deck coach in the original livery, different service number.

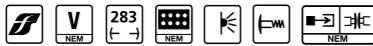

1010

Confezione di tre carrozze composta da: una carrozza pilota due piani di seconda classe e due carrozze due piani di seconda classe nella livrea d'origine con logo FS anni '70 "televisore".
Set composed by one 2nd class double deck pilot coach and two 2nd class double deck coaches in the original liveries with FS logo age '70.



3003

Carrozza due piani di seconda classe delle FS Trenitalia.
2nd class double deck coach of the FS Trenitalia.



3004

Carrozza due piani di seconda classe delle FS Trenitalia.
2nd class double deck coach of the FS Trenitalia.



3035

Carrozza due piani di 1/2 classe delle FS Trenitalia.
1st/2nd class double deck coach of the FS Trenitalia.



3072

Carrozza due piani di seconda classe nella livrea d'origine con logo FS inclinato.
2nd class double deck coach in the original livery.



3100

Carrozza due piani di seconda classe nella livrea d'origine con logo FS inclinato, diversa numerazione.
2nd class double deck coach in the original livery, different service number.

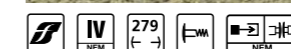

3066

Carrozza due piani di seconda classe nella livrea d'origine con logo FS anni '70, diversa numerazione.
2nd class double deck coach in the original livery with FS logo age '70 and different service numbers.

Carri merci - Freight wagons



3300
Carro pianale tipo Rs delle FS.
Rs flat car of the FS.

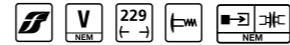

NEW



3313
Carro pianale tipo Rs del Portogallo "SOMAFEL".
Rs flat car of "SOMAFEL" Portugal.

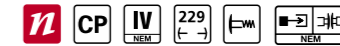

NEW



3314
Carro pianale tipo Rs del Portogallo "SOMAFEL", nuova numerazione.
Rs flat car of "SOMAFEL" Portugal, new service number.

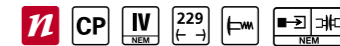

NEW



3315
Carro pianale tipo Rs del Portogallo "SOMAFEL", nuova numerazione.
Rs flat car of "SOMAFEL" Portugal, new service number.



3301
Carro pianale tipo Rs 680 delle DB, epoca IV.
Rs 680 flat car of the DB, epoch IV.

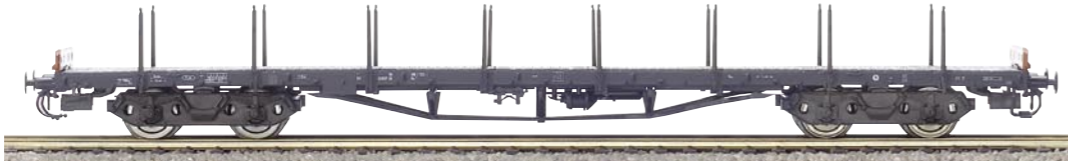
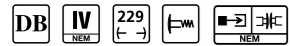

3310
Set di due carri pianale tipo SSImas 53 delle DB, IIIb epoca.
Set of two SSImas 53 flat cars of the DB, epoch IIIb.

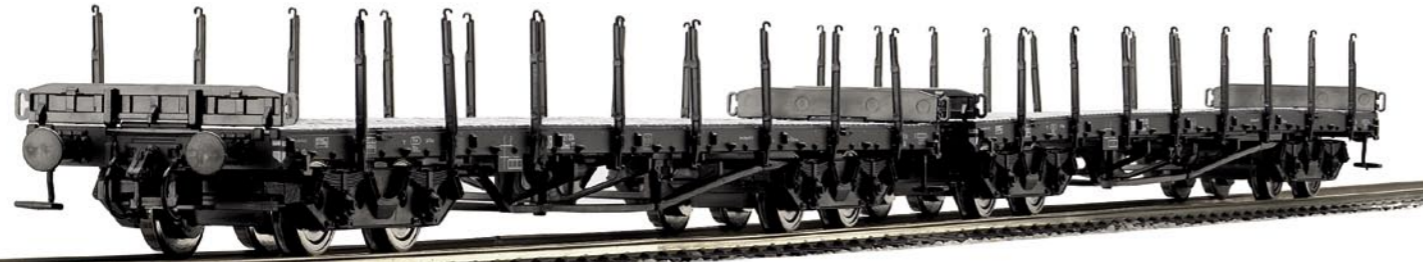
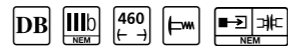

3312
Set di due carri pianale tipo Rs delle CFL.
Set of two Rs flat cars of the CFL.



3306
Carro pianale tipo Rs 802 delle SNCF.
Rs 802 flat car of the SNCF.

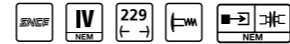

3302
Carro pianale tipo Rs delle SNCB.
Rs flat car of the SNCB.

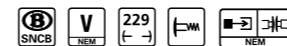

3309
Set di due carri pianale tipo Rs 802 delle SNCF.
Set of two Rs 802 flat cars of the SNCF.

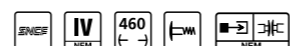

3308
Set di due carri pianale tipo Rs delle SNCB.
Set of two Rs flat cars of the SNCB.

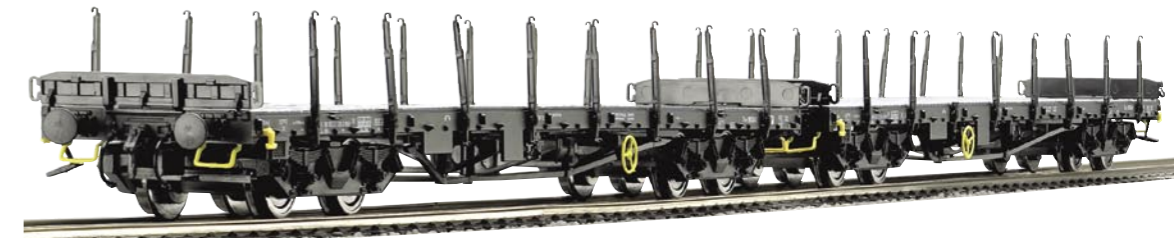
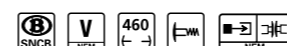

Pantografi - Pantographs



6042
Confezione 2 pantografi FS 42.
Box of 2 FS 42 pantographs.



6052
Confezione 2 pantografi FS 52.
Box of 2 FS 52 pantographs.



6043
Confezione 2 pantografi FS 42 LR unificato.
Box of 2 FS 42 LR pantographs.



6053
Confezione 2 pantografi FS 52/90 con strisciante piano.
Box of 2 FS 52/90 pantographs.



6050
Confezione 2 pantografi tipo AM Faiveley con strisciante SNCB.
Box of 2 pantographs w/AM Faiveley shoes SNCB.



6051
Confezione 2 pantografi tipo AM Faiveley con strisciante DB.
Box of 2 pantographs w/AM Faiveley shoes DB.



6055
Confezione 2 pantografi tipo AM Faiveley con strisciante SNCF.
Box of 2 pantographs w/AM Faiveley shoes SNCF.



6056
Confezione 2 pantografi tipo AM Faiveley con strisciante SBB.
Box of 2 pantographs w/AM Faiveley shoes SBB.



6072
Confezione 2 pantografi tipo AM 11 delle SNCF.
Box of 2 pantographs AM 11 shoes SNCF.



6073
Confezione 2 pantografi tipo AM Faiveley con strisciante FS.
Box of 2 pantographs w/AM Faiveley shoes FS.



6074
Confezione 2 pantografi FS 52/92 con strisciante piano.
Box of 2 FS 52/92 pantographs.



6077
Confezione 2 pantografi FS 32 con strisciante piano.
Box of 2 FS 32 pantographs.

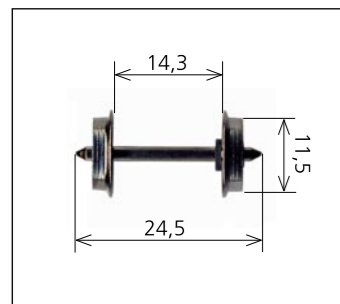

6047
Confezione 4 assali Ø 11,5 mm.
Box of 4 axles Ø 11,5 mm.

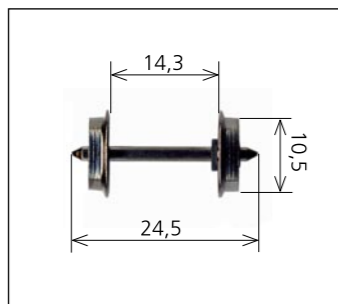

6048
Confezione 4 assali Ø 10,5 mm.
Box of 4 axles Ø 10,5 mm.

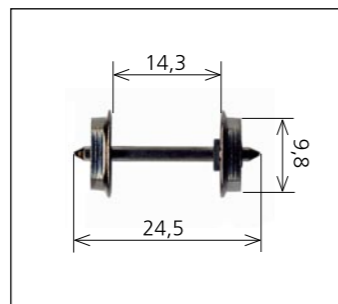

6049
Confezione 4 assali Ø 9,8 mm.
Box of 4 axles Ø 9,8 mm.

Binari - Tracks

4051
Binario flessibile set 24 pezzi L. 900 mm
Flexible track - Length 900 mm. Box of 24 pieces

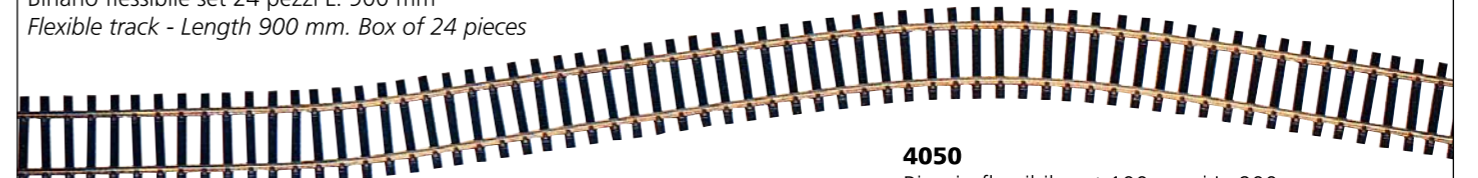

4050
Binario flessibile set 100 pezzi L. 900 mm
Flexible track - Length 900 mm. Box of 100 pieces

Illuminazione - Lighting

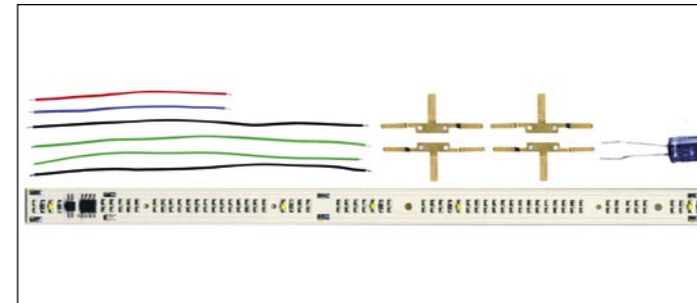

6075
Confezione contenente kit di illuminazione per la carrozza delle FS.
Lighting kit for passenger coach of the FS.

6076
Confezione contenente kit di illuminazione per le carrozze pilota MDVC delle FS.
Lighting kit for MDVC driving coach of the FS.

4101
Confezione 100 giunti metallici.
Metal fishplates. Box of 100 pcs.



Peco - Uhlenbrock Elektronik

Distributore per l'Italia.
Distributors for Italy.

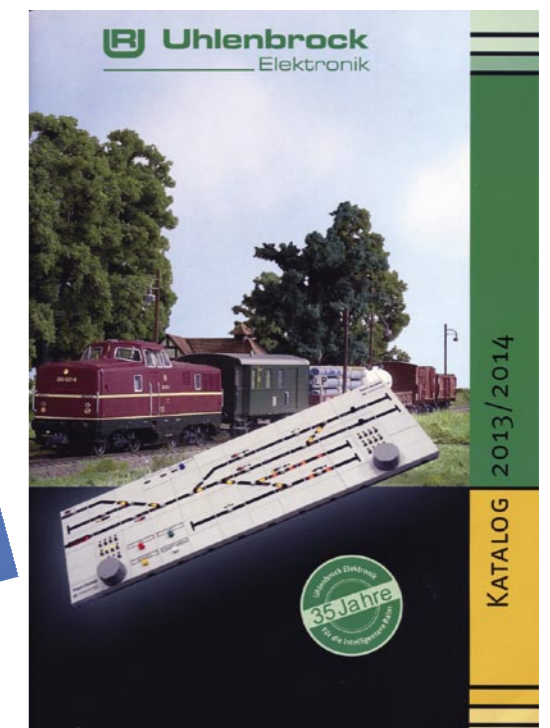
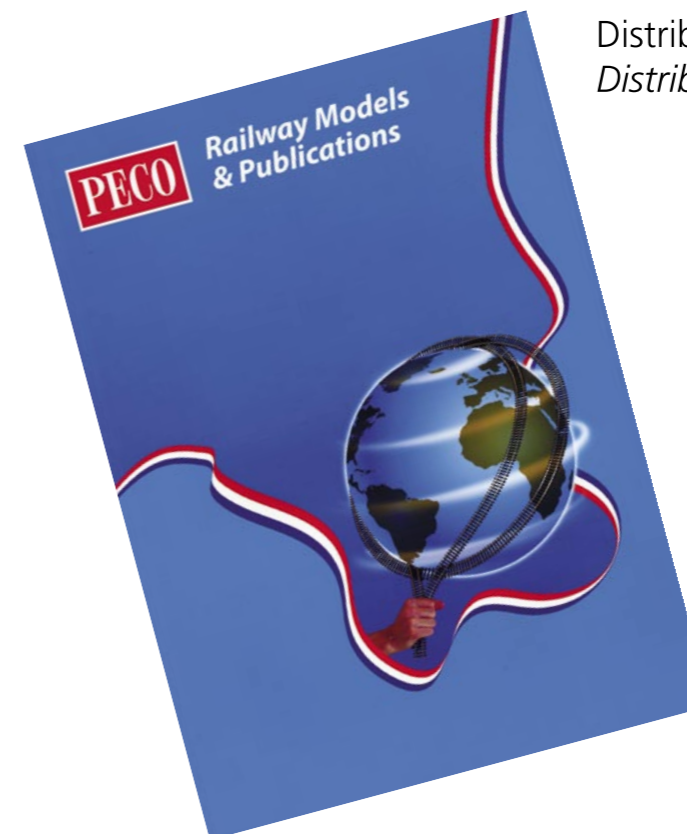



CMP Industrie S.p.A.
Via Ca' Zusto, 99 -
35010 Vigodarzere - PD - Italy
e-mail: vitrains@cmpindustrie.it
web address: www.vitrains.it



Export sales office:
A.W.E.C.O. srl - All World Export Company - Via C. Scarpa, 140
36100 Vicenza - Italy - web address: www.aweco.net
e-mail: info@aweco.net



2013
H0 1:87
Made in Italy

